

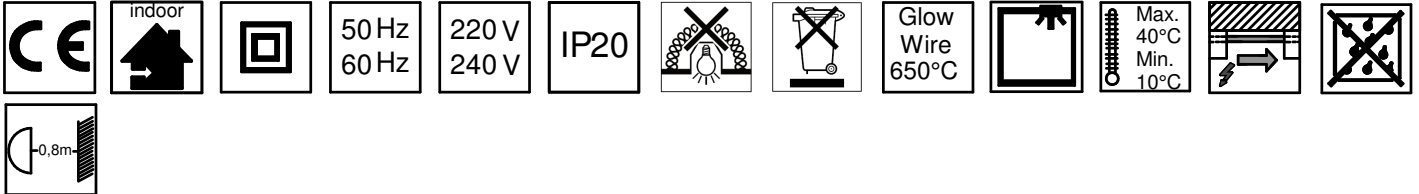

PHILIPS

GreenSpace Accent Cardanic

RS343B

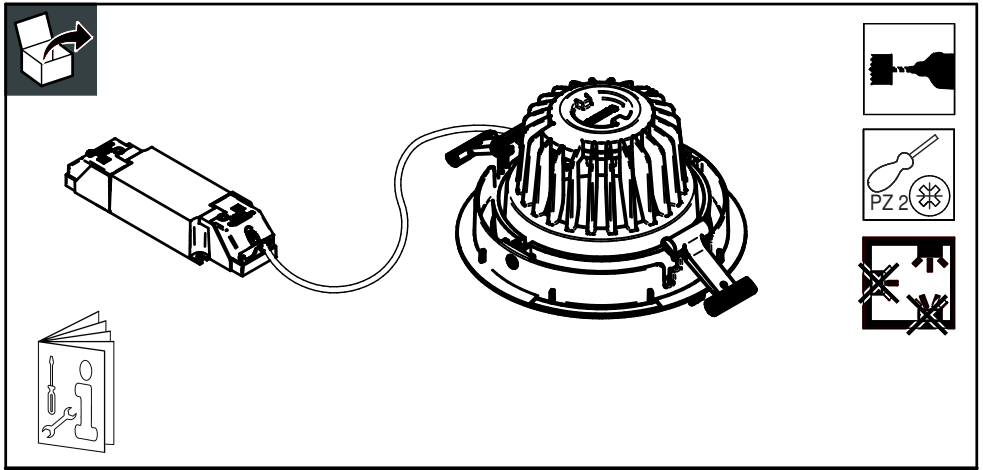

Model	Lumen package	Color Temperature [K]	
RS343B	LED17S	827/830/840/PW930	1,1
	LED19S	FMT/ROSE	1,1
	LED27S	827/830/840/CH/FR/PW930/FMT/ROSE/PC930	1,1
	LED39S	827/830/840/PW930/PC930	1,1
	LED49S	827/830/840	1,1



Product info

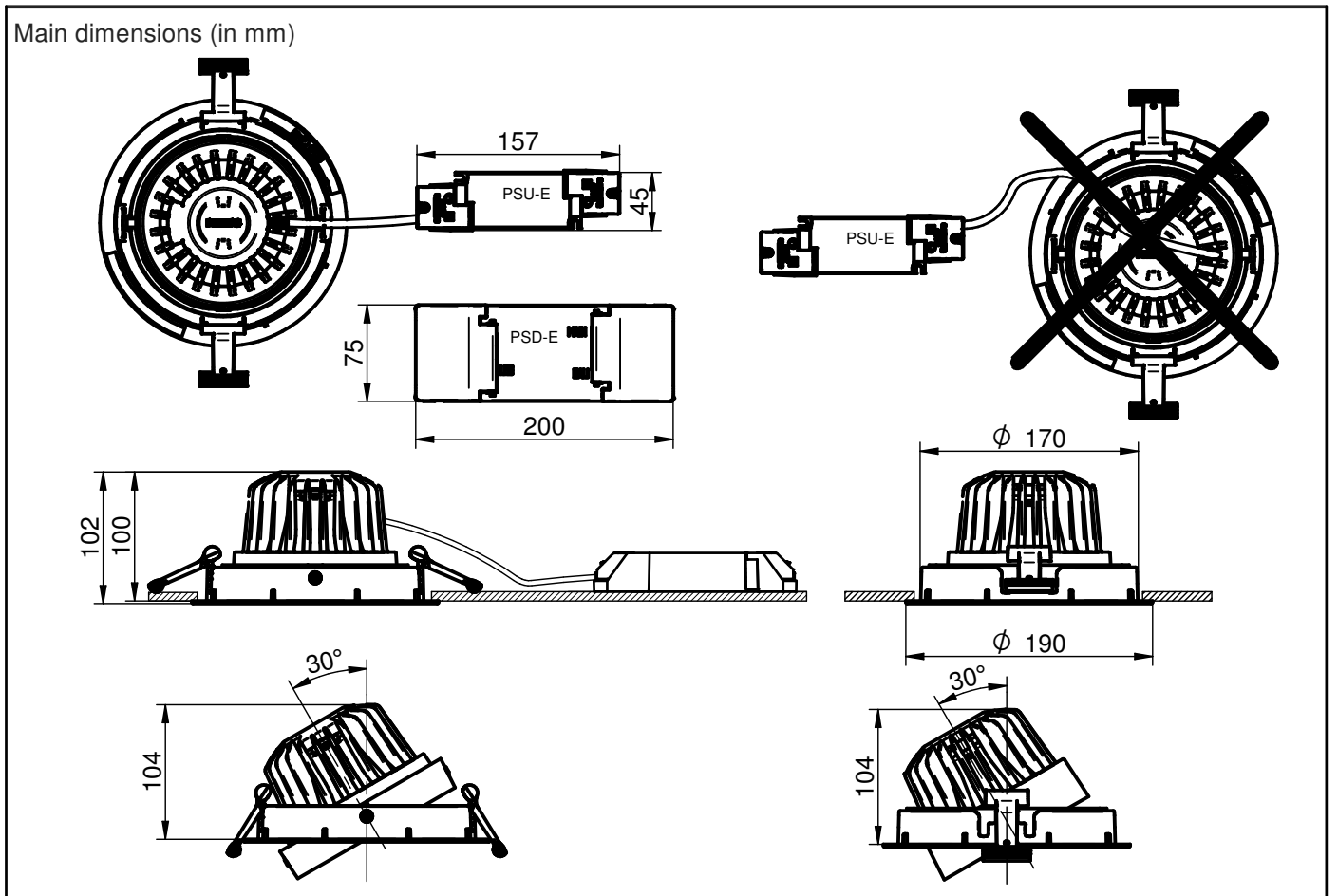

Installation positions

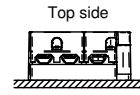
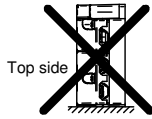
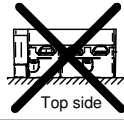
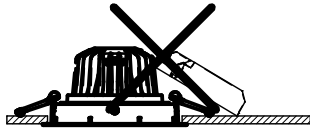

Built in box size

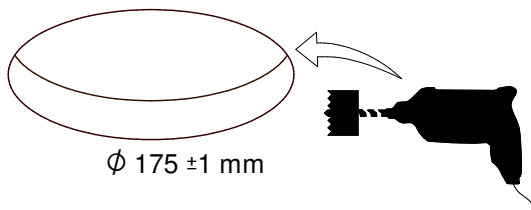
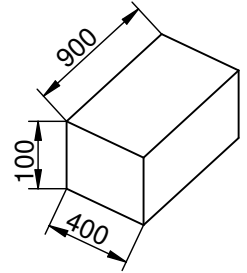
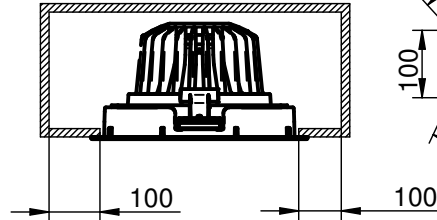
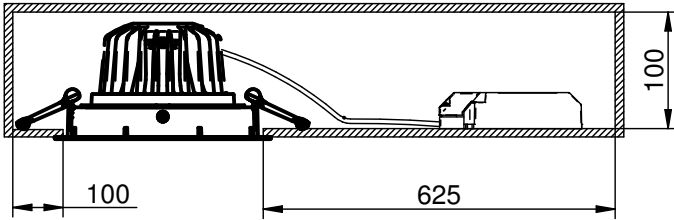

1a

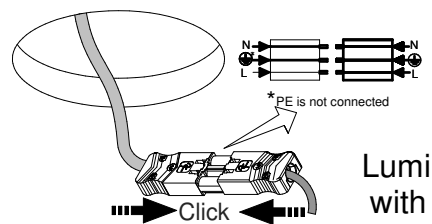
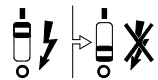

Luminaires with CW-L

1b

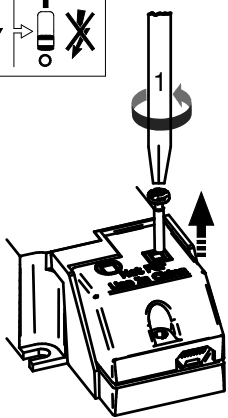
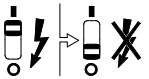

~ 220-240V

2a

PSU-E

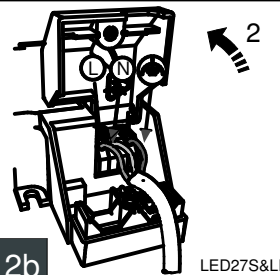
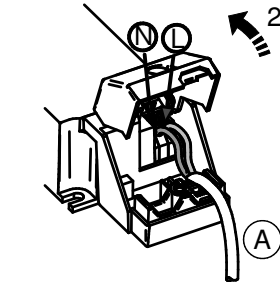

2b

LED27S&LED39S

A: ~220-240V cable

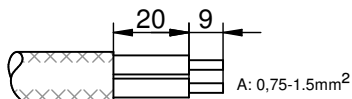

B: DALI cable

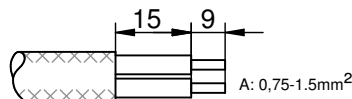

PSD-VLC-E

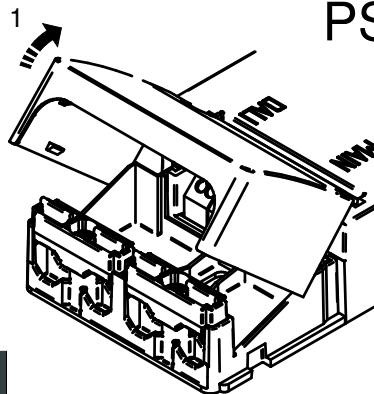

3a

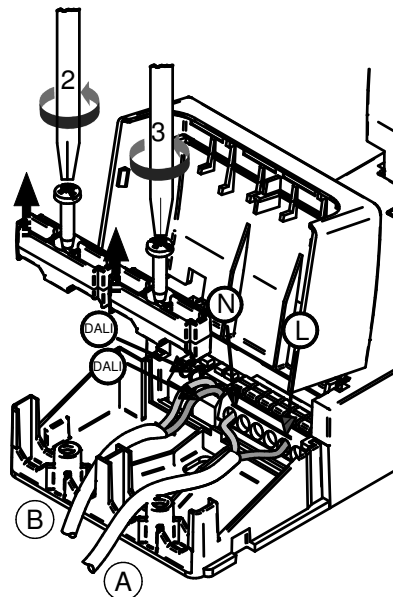

3b

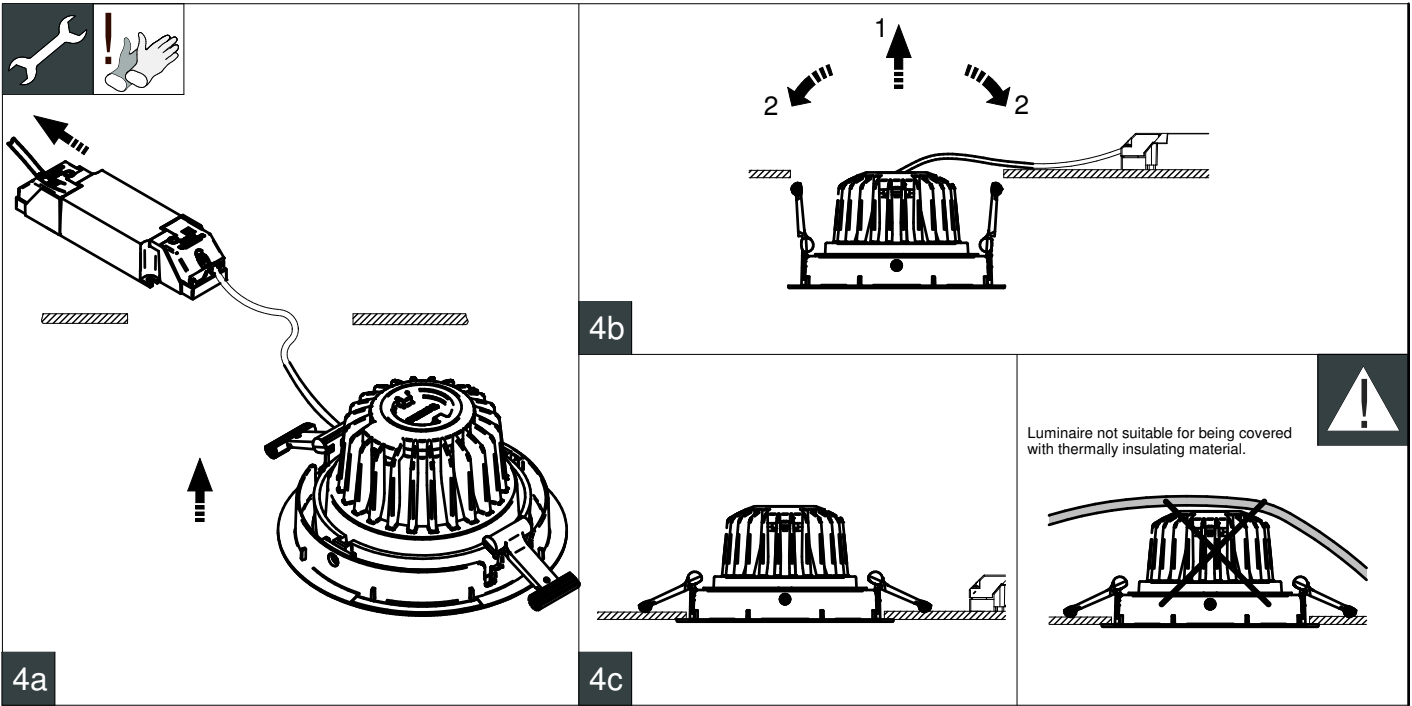

Inrush current

LED17S/827,830,840,PW930		LED19S/FMT,ROSE LED27S/PW930,ROSE/PC930		LED27S/827,830,840,CH,FR		LED39S/827,830,840		LED27S/FMT LED39S/PW930/PC930 LED49S/827,830,840	
20W PSU		36W PSU		28W PSU		34W PSU		50W PSU	
I _{peak} [A]	18,6	I _{peak} [A]	18,6	I _{peak} [A]	6,1	I _{peak} [A]	11	I _{peak} [A]	18
T _{ref} [us]	240	T _{ref} [us]	240	T _{ref} [us]	310	T _{ref} [us]	306	T _{ref} [us]	250
MCB	Max products [pcs]*	MCB	Max products [pcs]*	MCB	Max products [pcs]*	MCB	Max products [pcs]*	MCB	Max products [pcs]*
B-16A type B	≤34	B-16A type B	≤34	B-16A type B	≤34	B-16A type B	≤34	B-16A type B	≤30

PSU-E					
LED17S/827,830,840,PW930		LED19S/FMT,ROSE LED27S/827,830,840,PW930,CH,FR, ROSE/PC930 LED39S/827,830,840		LED27S/FMT LED39S/PW930/PC930 LED49S/827,830,840	
20W PSD-VLC-E		36W PSD-VLC-E		50W PSD-VLC-E	
I _{peak} [A]	20,4	I _{peak} [A]	20,4	I _{peak} [A]	24,9
T _{ref} [us]	195	T _{ref} [us]	195	T _{ref} [us]	186
MCB	Max products [pcs]*	MCB	Max products [pcs]*	MCB	Max products [pcs]*
B-16A type B	≤24	B-16A type B	≤24	B-16A type B	≤27

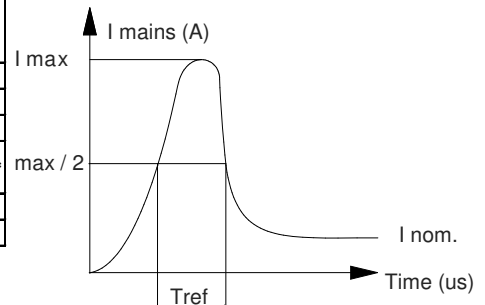

5

- ❑ The luminaire shall be installed by a qualified electrician and wired in accordance with the latest IEE electrical regulations or the national requirements.
- ❑ Caution, risk of electric shock. The light source of this luminaire is not replaceable, when the light source reaches its end of life the whole luminaire shell be replaced. The driver shall only be replaced by the manufacturer or his service agent or a similar qualified person.
- ❑ The luminaire shall, under no circumstance, be covered with thermal insulation matting or similar material.



Optical unit replacement

ONLY available for NB, MB, and WB! VWB reflectors can not be replaced, or be put into a non VWB lamp!

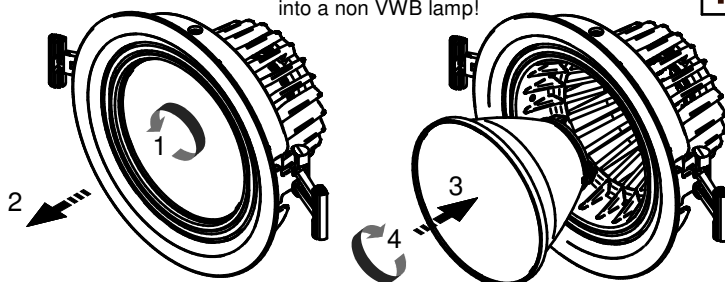

6

Optical unit cleaning

Only use a soft cloth!

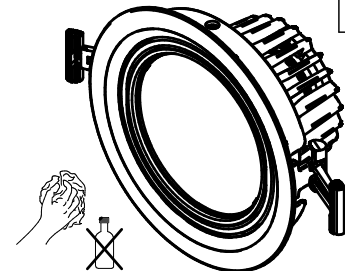

7

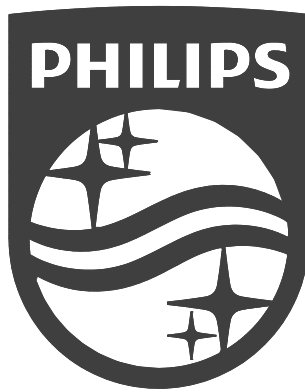

© 2018 Signify Holding.

All rights reserved. This document contains information relating to the product portfolio of Signify which information may be subject to change. No representation or warranty as to the accuracy or completeness of the information included herein is given and any liability for any action in reliance thereon is disclaimed. The information presented in this document is not intended as any commercial offer and does not form part of any quotation or contract. Philips and the Philips Shield Emblem are registered trademarks of Koninklijke Philips N.V.. All other trademarks are owned by Signify Holding or their respective owners.

Signify Holding.
The Netherlands