



CorePro LED PLC 4P

CorePro LED PLC 6.5W 840 4P G24q-2

De Philips CorePro LED PLC 4P is een LED-lichtbron in de vorm van een traditionele fluorescentielamp. Dit product vormt de ideale oplossing voor het opwaarderen van TL-verlichting in algemene verlichtingstoepassingen; het voldoet aan de basiseisen voor verlichting, biedt aanzienlijke energiebesparingen en is milieuvriendelijk.

Product gegevens

Algemene informatie

Lampvoet	G24Q-2 [G24q-2]
Conform EU RoHS-richtlijn	Ja
Nominale levensduur (nom.)	30000 h
Schakelcyclus	50.000X

Eisen aan armatuurontwerp

Kleurcode	840 [CCT of 4000K (841)]
Bundelhoek (nom.)	120 °
Lichtstroom (nom.)	700 lm
Kleuraanduiding	Koel Wit (CW)
Georreleerde kleurtemperatuur (nom.)	4000 K
Lichtrendement (gespec.) (nom.)	92,31 lm/W
Kleurconsistentie	<6
Kleurweergave-index (nom.)	83
Llmf bij einde nominale levensduur (nom.)	70 %

Bedrijfs- en Elektrische gegevens

Ingangsfrequentie	30000-80000 Hz
Power (Rated) (Nom)	6,5 W
Lampstroom (max.)	300 mA
Lampstroom (min.)	150 mA
Opstarttijd (nom.)	0,5 s

Opwarmtijd tot 60% lichtopbrengst (nom.)	0.5 s
Power Factor (nom.)	0.9
Spanning (nom.)	20-50 V

Temperatuur

T-omgeving (max.)	35 °C
T-omgeving (min.)	-20 °C
T-opslag (max.)	65 °C
T-opslag (min.)	-40 °C
T-behuizing maximaal (nom.)	66 °C

Regelsystemen en Dimmers

Dimbaar	Nee
---------	-----

Mechanische eigenschappen en Behuizing

Productlengte	100 mm
---------------	--------

Goedkeuring en Toepassing

Energie-efficiëntielabel (EEL)	A+
Energiebesparend product	Yes
Goedkeuringsmerktokens	CE-markering RoHS compliance KEMA Keur-certificaat

CorePro LED PLC 4P

Energieverbruik kWh/1000 uur	9 kWh
Productgegevens	
Volledige productcode	871869654121000
Productnaam voor bestelling	CorePro LED PLC 6.5W 840 4P G24q-2
EAN/UPC - Product	8718696541210
Bestelcode	54121000

Local Code	CPLC6.5W840Q2
Numerator - Aantal per pak	1
Numerator - Dozen per buitendoos	10
Materiaalnr. (12NC)	929001201102
Netto gewicht (per stuk)	0,078 kg

Maatschets

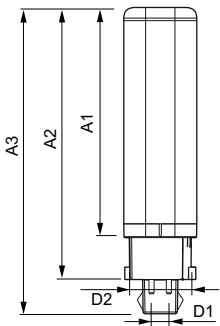

LEDtube PLC 6.5W G24q-2/840 4P

Product	D1	D2	A1	A2	A3
CorePro LED PLC 6.5W 840 4P G24q-2	24,3 mm	28,4 mm	105,8 mm	125 mm	140,6 mm

Fotometrische gegevens

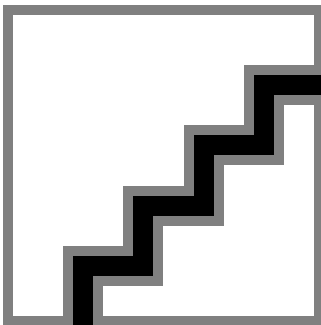

LEDtube PLC 100mm 7W G24Q-2 840 700lm

LEDtube PLC 100mm 9W G24Q-3 840 1000lm

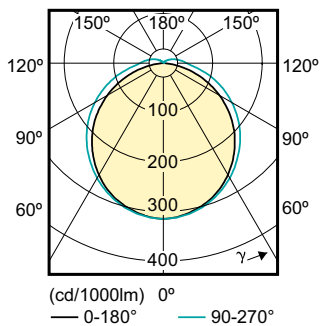

CorePro LED PLC 4P

Levensduur

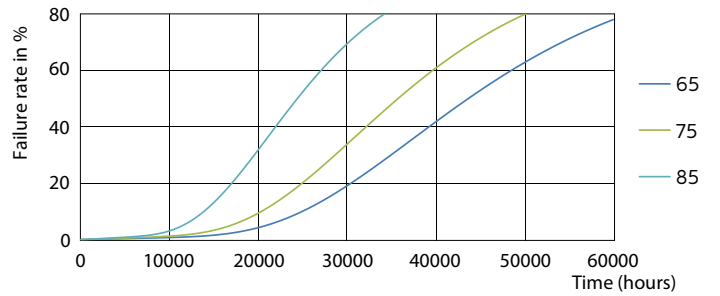
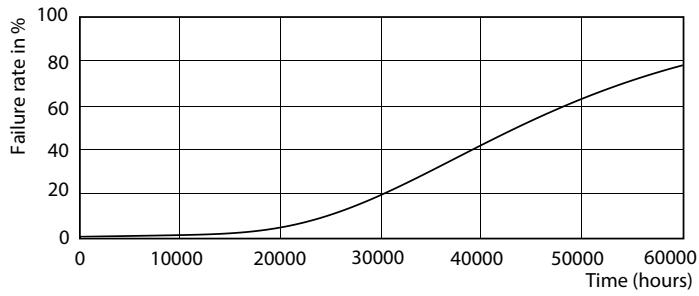

LEDtube PLC 100mm 7W G24Q-2 830 650lm

LEDtube PLC 100mm 7W G24Q-2 830 650lm

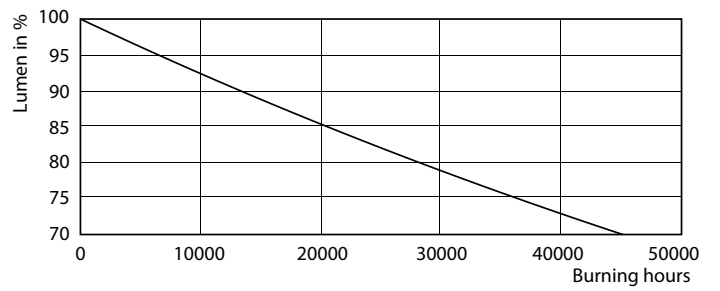
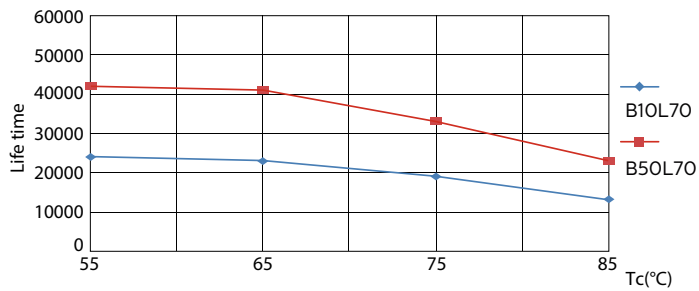

LEDtube PLC 100mm 7W G24Q-2 830 650lm

LEDtube PLC 100mm 7W G24Q-2 830 650lm

LEDtube PLC 100mm 7W G24Q-2 830 650lm

CorePro LED PLC 4P

